

S. Det är lampligt att denna information överlämnas till användaren av anläggningen.
GB. It is appropriate that this information is passed on to the user of the installation.

D. Diese Informationen sind für den Benutzer der Anlage vorgesehen.
SF. Tämä ohje on suositeltava luovuttaa.

Montageanvisning Plain

Assembly instruction Plain

PLAIN 600
 Dimensioner för utskärning
 Dimensions for cut-out

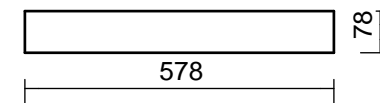

Anslutningskabel

Flertrådig eller solid ledare upp till 2.5mm² kan användas för inkoppling. Kablarna bör skalas 10-11 mm för att säkerställa optimal inkoppling i plintarna. Använd endast en ledare per inkopplingsplint. Använd endast en kabel per avlastare.

Mains supply wires

Stranded wire or solid wire up to 2.5 mm² may be used for wiring. Strip 10-11 mm of insulation from the cables to ensure perfect operation of the push terminals. Use one wire for each terminal connector only. Use each strain relief channel for one cable only.

S. Om armaturens kabel eller don skulle skadas eller om armaturen inte fungerar som den ska, skall dessa komponenter kontrolleras/bytas av tillverkaren eller av tillverkarens utsedd person.

GB. If the luminaire cable or driver is damaged or if the luminaire is not working properly, it shall exclusively be checked/replaced by the manufacturer or by the manufacturer designated person.

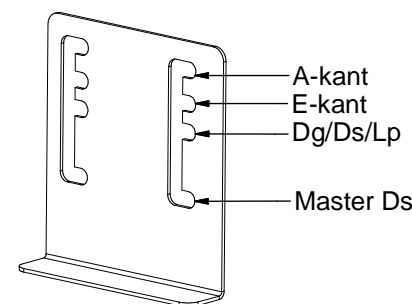
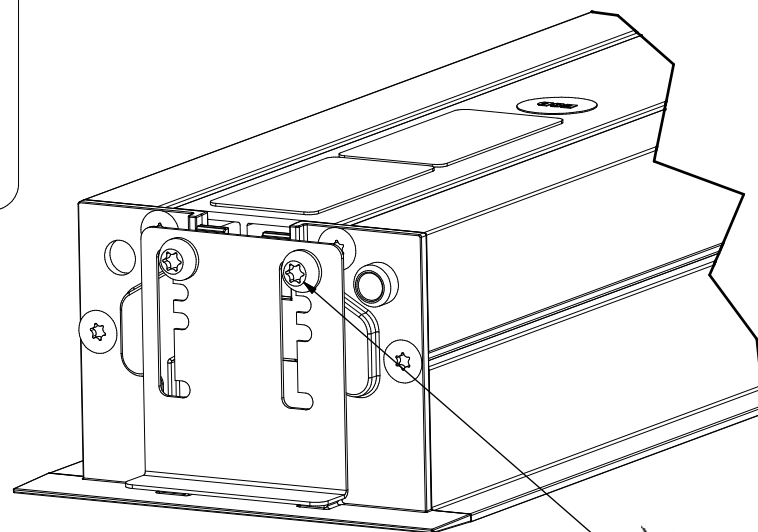

Monteras LED riktad mot vägg
 Mounted LED facing wall

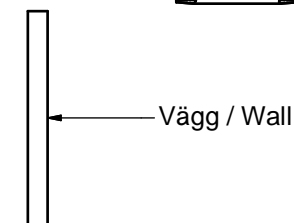

Torx T10

ateljé Lyktan

SE-296 81 Åhus, Sweden
 Tel: +46 44 28 98 00
 Fax: +46 28 98 38
 info@atelje-lyktan.se
 www.atelje-lyktan.se



"The light source shall only be replaced by the manufacturer or his designated person."
 Ljuskällan ska enbart bytas ut av tillverkaren eller hans utsedda person

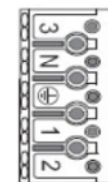

L
 N
 DA+
 DA-



Grundläggande isolering mellan nät och styr ledning
 Basic insulation between mains and control wiring

MA2001
 2018-08-10
 RAJU

S. Det är lämpligt att denna information överlämnas till användaren av anläggningen.
GB. It is appropriate that this information is passed on to the user of the installation.

D. Diese Informationen sind für den Benutzer der Anlage vorgesehen.
SF. Tämä ohje on suositeltava luovuttaa.

Montageanvisning PLAIN

Assembly instruction PLAIN

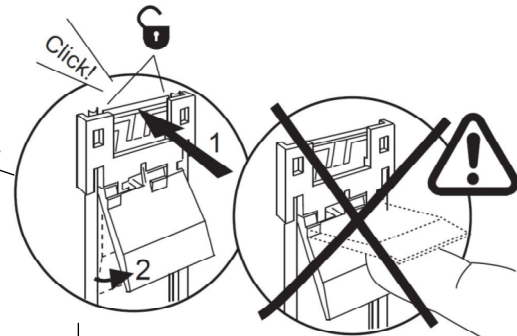

Anslutningskabel

Flertrådig eller solid ledare upp till 2.5mm² kan användas för inkoppling. Kablarna bör skalas 10-11 mm för att säkerställa optimal inkoppling i plintarna. Använd endast en ledare per inkopplingsplint. Använd endast en kabel per avlastare.

Mains supply wires

Stranded wire or solid wire up to 2.5 mm² may be used for wiring. Strip 10-11 mm of insulation from the cables to ensure perfect operation of the push terminals. Use one wire for each terminal connector only. Use each strain relief channel for one cable only.

S. Om armaturens kabel eller don skulle skadas eller om armaturen inte fungerar som den ska, skall dessa komponenter kontrolleras/bytas av tillverkaren eller av tillverkaren utsedd person.

GB. If the luminaire cable or driver is damaged or if the luminaire is not working properly, it shall exclusively be checked/replaced by the manufacturer or by the manufacturer designated person.

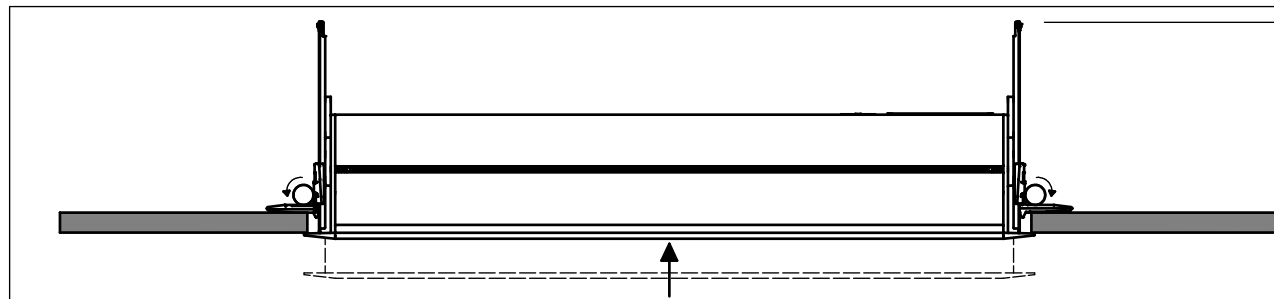
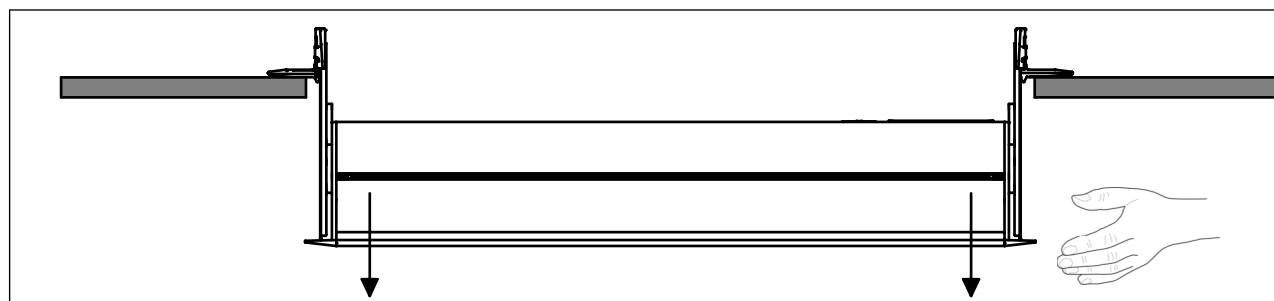
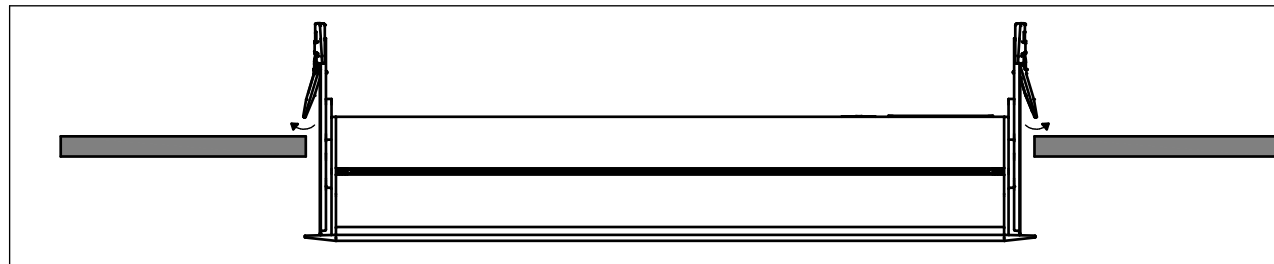
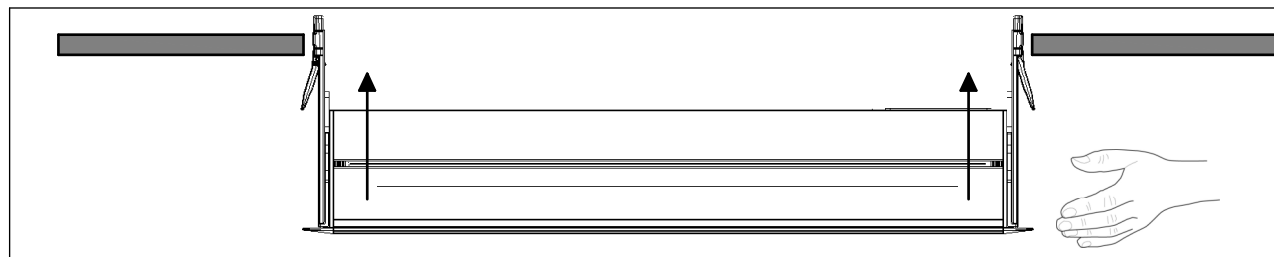
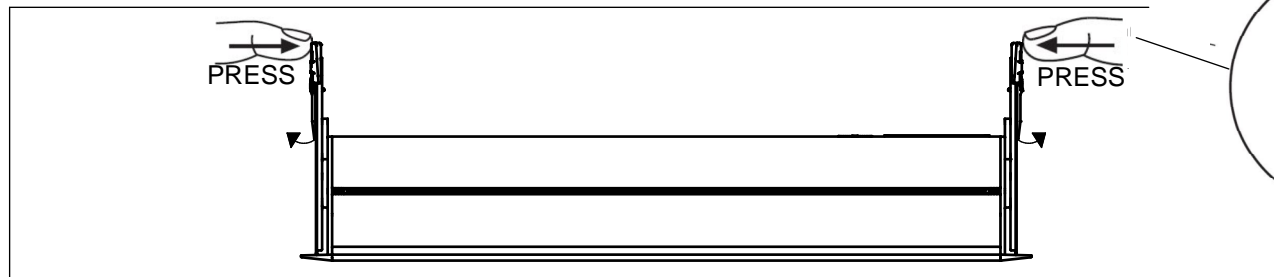

PLAIN 300
 Dimensioner för utskärning
 Dimensions for cut-out

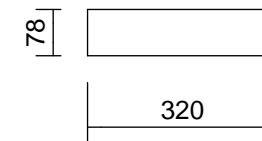

PLAIN 600
 Dimensioner för utskärning
 Dimensions for cut-out

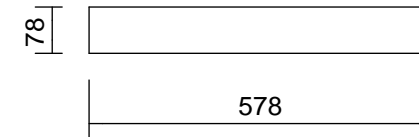

Monteras LED riktad mot vägg
 Mounted LED facing wall

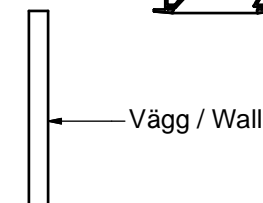

85
INFÄLLNADSDJUP / RECESS DEPTH

ateljé Lyktan

SE-296 81 Åhus, Sweden
 Tel: +46 44 28 98 00
 Fax: +46 28 98 38
 info@atelje-lyktan.se
 www.atelje-lyktan.se

MA2002
 2018-08-10
 RAJU
 Page 1/2

S. Det är lämpligt att denna information överlämnas till användaren av anläggningen.
GB. It is appropriate that this information is passed on to the user of the installation.

D. Diese Informationen sind für den Benutzer der Anlage vorgesehen.
SF. Tämä ohje on suositeltava luovuttaa.

Montageanvisning PLAIN

Assembly instruction PLAIN

Demontering/Dismounting procedure

Grundläggande isolering mellan nät och styrledning
 Basic insulation between mains and control wiring



L N DA+ DA-

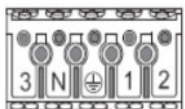

S. Om armaturens kabel eller don skulle skadas eller om armaturen inte fungerar som den ska, skall dessa komponenter kontrolleras/bytas av tillverkaren eller av tillverkarens utsedd person.

GB. If the luminaire cable or driver is damaged or if the luminaire is not working properly. It shall exclusively be checked/replaced by the manufacturer or by the manufacturer designated person.



ateljé Lyktan

SE-296 81 Åhus, Sweden
 Tel: +46 44 28 98 00
 Fax: +46 28 98 38
 info@ateljje-lyktan.se
 www.ateljje-lyktan.se

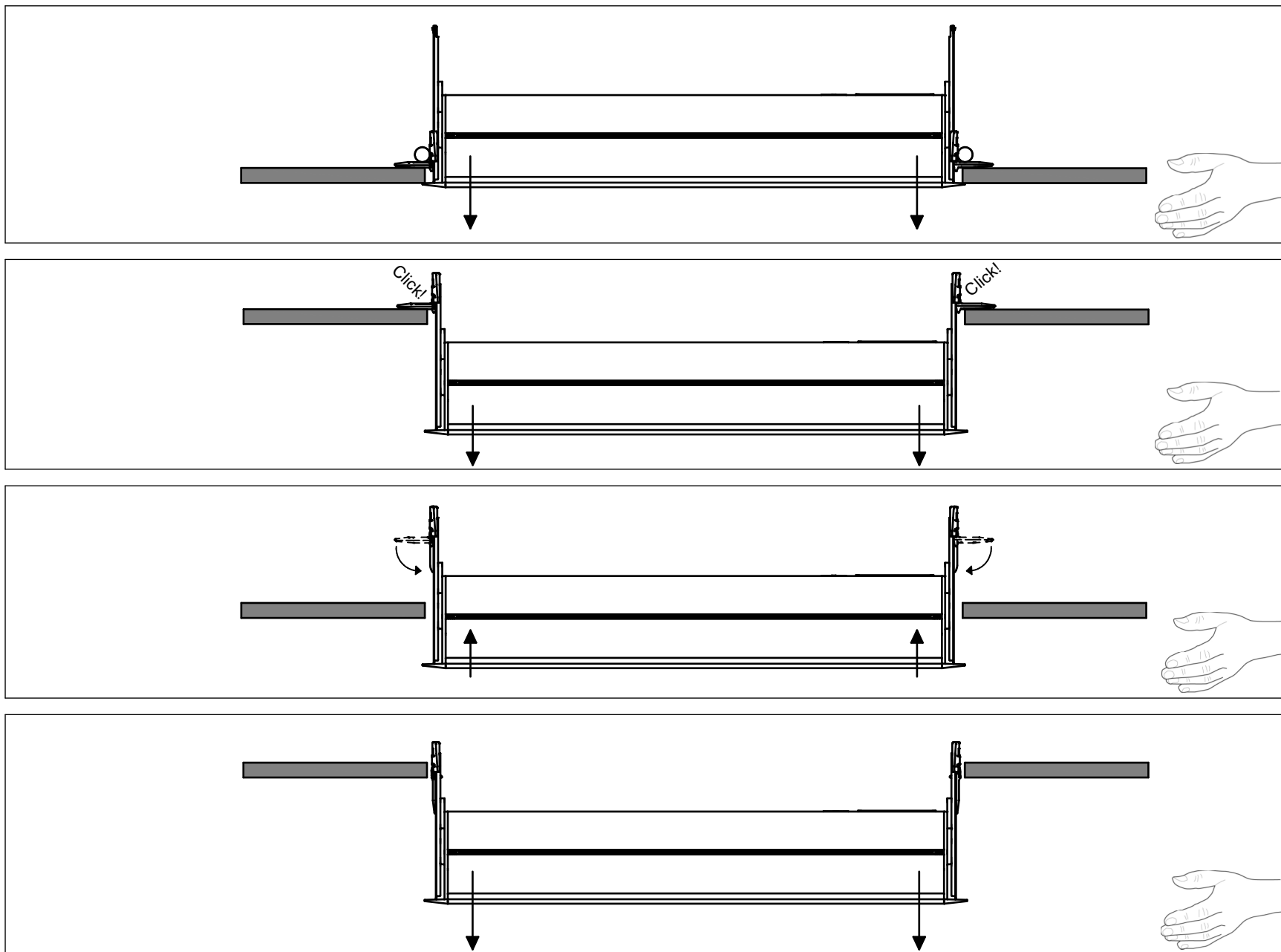

"The light source shall only be replaced by the manufacturer or his designated person."
 Ljuskällan ska enbart bytas ut av tillverkaren eller hans utsedd person

